

ABOUT LEFOO



LEFOO was founded in 2000, which is a National High-tech Enterprise of R&D, manufacturing, and sales.

LEFOO has been awarded "Little Giant" firms and "Specialized and Sophisticated Enterprises" by the Ministry of Industry and Information Technology of the People's Republic of China. LEFOO is a group company with 3 subsidiary corporations,

LEFOO Industrial Co., Ltd, LEFOO Controls Co., Ltd, and Zhejiang LEFOO Sensing Technology Co., Ltd. LEFOO is committed to become the leading and world-class enterprise in R&D and manufacturing to supply professional water pumps, mechanical structure controls, electronic digital sensing controls, which can be widely used in water purification, water treatment, home appliances, drink and beverage, environmental control, mechanical equipment, intelligent equipment, medical, power, Internet of things, and other industrial fields.

LEFOO already passed international management system certifications of ISO9001, ISO16949, ISO45001, ISO14001 and LEFOO has passed many product certifications of CE, RoHS, FDA, NSF, UL, CSA, 3C that authorized by TUV and SGS. LEFOO has more than 130 patents in total, includes 9 patents for invention. Over the past 20 years, LEFOO's market throughout more than 80 countries and regions in North America, South America, Europe, Asia, Africa, and Australia. As a professional and trustworthy supplier, LEFOO has cooperated and established strategic partnership with many great companies, Fortune Global 500, and world-famous brands.

"Quality & Service First, Focus on Technology & Innovation", adhering to this philosophy, LEFOO will continue to do best to meet the growing market requirements, provide advanced, reliable and exquisite products and service to all of customers.

DEMAND / DELIVERY PUMP

Product Overview //

Demand / delivery pump is a diaphragm positive displacement pump, the diaphragm plate plays a sealing and protective role in isolating the conveying medium and the power end (motor), and the regular movement of the diaphragm plate changes the volume of the studio, thereby inhaling and discharging the liquid to achieve liquid transportation and pressurization. The pump head is provided with a micro-switch through the valve plate, and the micro-switch forms a series effect with the motor end. When the pressure rises, the valve disc deforms under the pressure, triggering the micro-switch to power off; When the pressure is reduced, the valve disc recovers the deformation, and the micro-switch recovers the power, so as to realize the automatic start and stop. Multi-field application, can be used for RV water supply, Marine yacht water supply, solar water pump system, faucet end pressurization, automatic filling equipment, liquid vending machine, equipment water circulation cooling, water purification and drinking water, agricultural spray system, high pressure cleaning system and so on.



Application Area //



Rv, boat and yacht water supply



Solar water pump faucet end pressurization automatic filling equipment



Vending Machines



Water circulating and cooling. Water purification and drinking.



Agricultural spraying system. High pressure cleaning system.

Product Features //

- **Motor:** Fully enclosed permanent magnet motor
- **Base:** Metal base with cushioned Rubber pads
- **Inlet and outlet:** 3/8" Female quick connector. NPT3/8 thread
- **Type:** Three-chamber diaphragm pressurization
- **Materials for wading parts:** Pump head housing: Nylon
Valve plate: EPDM
Diaphragm: Santoprene
Fastener: Stainless steel
- **Temperature protection:** For user safety and maximum motor life, the motor is equipped with a thermal protector, and when the shell temperature reaches 73 °C, the operation is disconnected

Features and advantages

- **Automatic start-stop**
Can achieve high voltage power off, low voltage start
- **High performance motor**
All copper motor, strong power, low temperature rise, continuous work
- **Multiple pressure break points**
The pressure is adjustable from 30 to 100PSI
- **Integrated reflux relief device**
Bypass reflux reduces frequent start and stop of the pressure switch
- **High self priming capacity**
Self-priming height ≥2 meters, suction cavity and discharge cavity for three independent structure, high stability
- **Smooth flow**
The outlet end is designed with buffer structure, which has lower water pulse and vibration
- **High strength**
The bearing parts are reinforced nylon and aluminum alloy
- **Processize**
Electrical, sealing, pressurization and other performance production process full inspection control

Low electromagnetic noise and vibration ...
The motor adopts an integrated magnetization process, with lower electromagnetic noise and vibration

Good water resistance ...
Full range IPX5

Check function ...
Non-reverse structure design to prevent the backflow of the medium

Overheat protection ...
Equipped with a thermal protector, the pump shell temperature is higher than 73 °C, can realize automatic stop work

Authoritative certification ...
ROSH, CE, CQC, REACH Certification

High stability ...
Stable output and disconnect pressure, long life

LFP0060T

0.6GPM Automatic Shut-Off Demand/Delivery Diaphragm Pump



○ Flow Rate Curve

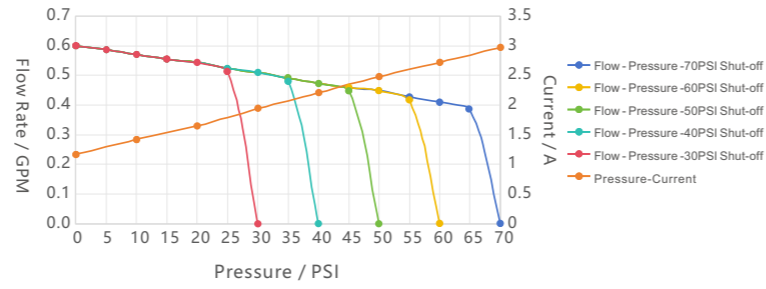

○ Temperature Rise Curve

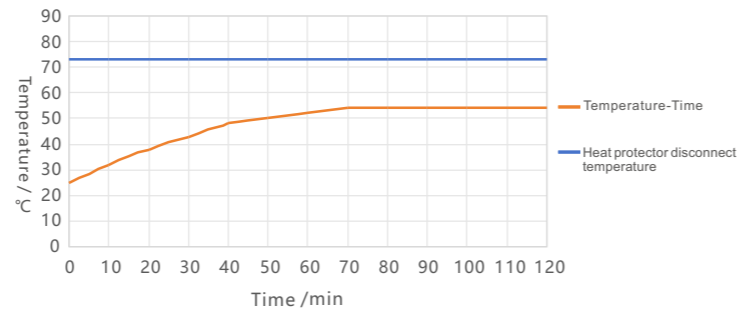

○ Performance data and curves

Data were tested at inlet pressure of 0PSI, ambient temperature and water temperature of 25°C. The above test data are based on a standard pipe of 3/8".

○ Temperature rise curve

The temperature rise curve is measured by the ambient temperature of 25°C, the inlet pressure of 0PSI, and the working pressure of 70PSI. In order to ensure the safety of the motor, the housing temperature exceeds approximately 73 °C, and the thermal protector is disconnected to cool the motor. The motor will be continuous working when the actual temperature rise of the motor is lower than the thermal protection disconnection temperature. All performance data and temperature curves are approximate, and actual conditions will vary with ambient conditions such as temperature.

○ Performance parameter

| Discharge Pressure /PSI | Flow Rate /GPM | Flow Rate /LPM | Current /A |
|-------------------------|----------------|----------------|------------|
| 0 | 0.60 | 2.27 | 1.17 |
| 10 | 0.57 | 2.16 | 1.42 |
| 20 | 0.54 | 2.06 | 1.65 |
| 30 | 0.51 | 1.93 | 1.94 |
| 40 | 0.47 | 1.79 | 2.21 |
| 50 | 0.45 | 1.70 | 2.48 |
| 60 | 0.41 | 1.55 | 2.72 |
| 70 | 0.38 | 1.44 | 2.97 |

○ Shut-off pressure for selection

| Selection | Rated voltage | Inlet Water Pressure | Working Flow Rate | Working Current | Suction | Shut-off Pressure | Maximum current | Connection |
|----------------|---------------|----------------------|-------------------|-----------------|---------|-------------------|-----------------|--|
| LFP0060T-30070 | 12V DC | 0PSI | 0.6GPM | ≤1.8A | ≥2M | 70PSI | ≤3.6A | 3/8" side female quick connector NPT3/8 Screw thread |
| LFP0060T-30060 | | | | | | 60PSI | ≤3.3A | |
| LFP0060T-30050 | | | | | | 50PSI | ≤3.1A | |
| LFP0060T-30040 | | | | | | 40PSI | ≤2.8A | |
| LFP0060T-30030 | | | | | | 30PSI | ≤2.5A | |

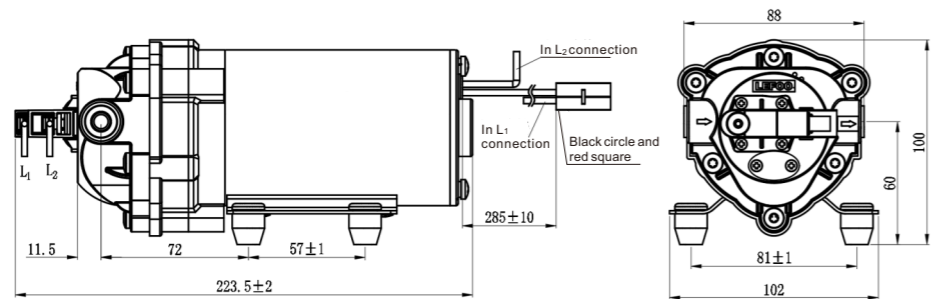

LFP0075T

12VDC 0.75GPM Automatic Shut-Off Demand/Delivery Diaphragm Pump



○ Flow Rate Curve

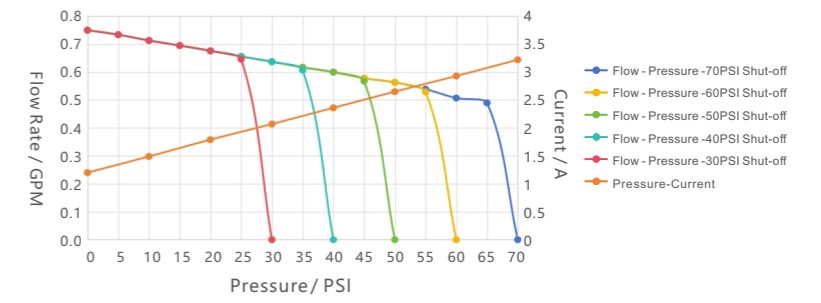

○ Temperature Rise Curve

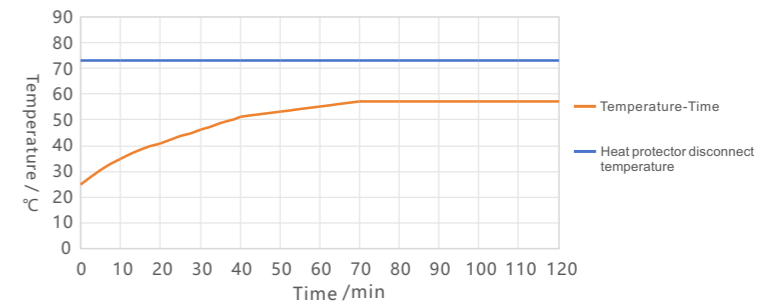

○ Performance data and curves

Data were tested at inlet pressure of 0PSI, ambient temperature and water temperature of 25°C. The above test data are based on a standard pipe of 3/8".

○ Temperature rise curve

The temperature rise curve is measured by the ambient temperature of 25°C, the inlet pressure of 0PSI, and the working pressure of 70PSI. In order to ensure the safety of the motor, the housing temperature exceeds approximately 73 °C, and the thermal protector is disconnected to cool the motor. The motor will be continuous working when the actual temperature rise of the motor is lower than the thermal protection disconnection temperature. All performance data and temperature curves are approximate, and actual conditions will vary with ambient conditions such as temperature.

○ Performance parameter

| Discharge Pressure /PSI | Flow Rate /GPM | Flow Rate /LPM | Current /A |
|-------------------------|----------------|----------------|------------|
| 0 | 0.75 | 2.84 | 1.2 |
| 10 | 0.71 | 2.70 | 1.49 |
| 20 | 0.68 | 2.56 | 1.79 |
| 30 | 0.64 | 2.41 | 2.07 |
| 40 | 0.60 | 2.27 | 2.36 |
| 50 | 0.56 | 2.13 | 2.65 |
| 60 | 0.51 | 1.92 | 2.93 |
| 70 | 0.48 | 1.81 | 3.22 |

○ Shut-off pressure for selection

| Selection | Rated voltage | Inlet Water Pressure | Working Flow Rate | Working Current | Suction | Shut-off Pressure | Maximum current | Connection |
|----------------|---------------|----------------------|-------------------|-----------------|---------|-------------------|-----------------|--|
| LFP0075T-30070 | 12V DC | 0PSI | 0.75GPM | ≤2.0A | ≥2M | 70PSI | ≤3.8A | 3/8" side female quick connector NPT3/8 Screw thread |
| LFP0075T-30060 | | | | | | 60PSI | ≤3.6A | |
| LFP0075T-30050 | | | | | | 50PSI | ≤3.3A | |
| LFP0075T-30040 | | | | | | 40PSI | ≤3.0A | |
| LFP0075T-30030 | | | | | | 30PSI | ≤2.7A | |

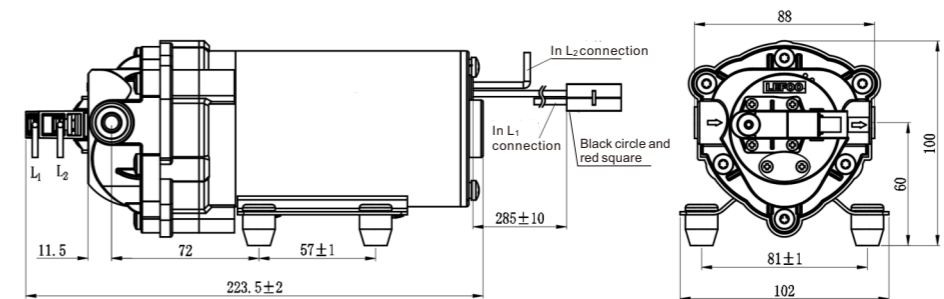

LFP0085T

0.85GPM Automatic Shut Off Demand/Delivery Diaphragm Pump



○ Flow Rate Curve

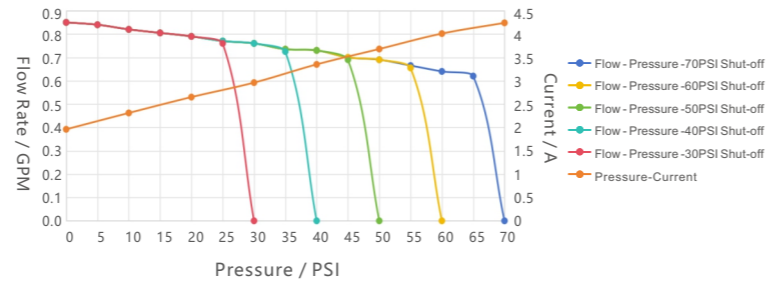

○ Temperature Rise Curve

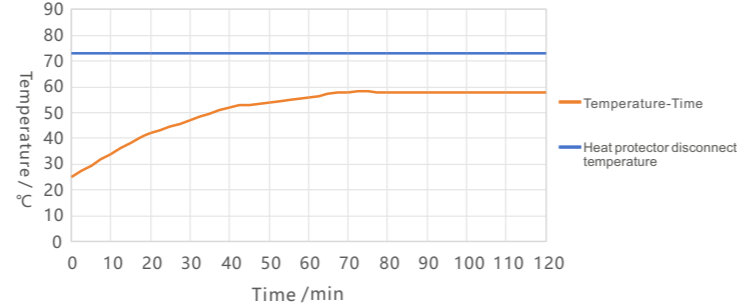

○ Performance data and curves

Data were tested at inlet pressure of 0PSI, ambient temperature and water temperature of 25°C. The above test data are based on a standard pipe of 3/8".

○ Temperature rise curve

The temperature rise curve is measured by the ambient temperature of 25°C, the inlet pressure of 0PSI, and the working pressure of 70PSI. In order to ensure the safety of the motor, the housing temperature exceeds approximately 73 °C, and the thermal protector is disconnected to cool the motor. The motor will be continuous working when the actual temperature rise of the motor is lower than the thermal protection disconnection temperature. All performance data and temperature curves are approximate, and actual conditions will vary with ambient conditions such as temperature.

○ Performance parameter

| Discharge Pressure /PSI | Flow Rate /GPM | Flow Rate /LPM | Current /A |
|-------------------------|----------------|----------------|------------|
| 0 | 0.85 | 3.22 | 1.96 |
| 10 | 0.82 | 3.12 | 2.31 |
| 20 | 0.79 | 2.99 | 2.65 |
| 30 | 0.76 | 2.89 | 2.96 |
| 40 | 0.73 | 2.76 | 3.35 |
| 50 | 0.69 | 2.63 | 3.68 |
| 60 | 0.64 | 2.42 | 4.01 |
| 70 | 0.61 | 2.31 | 4.24 |

○ Shut-off pressure for selection

| Selection | Rated voltage | Inlet Water Pressure | Working Flow Rate | Working Current | Suction | Shut-off Pressure | Maximum current | Connection |
|----------------|---------------|----------------------|-------------------|-----------------|---------|-------------------|-----------------|--|
| LFP0085T-30070 | 12V DC | 0PSI | 0.85GPM | ≤2.5A | ≥2M | 70PSI | ≤4.8A | 3/8" side female quick connector NPT3/8 Screw thread |
| LFP0085T-30060 | | | | | | 60PSI | ≤4.6A | |
| LFP0085T-30050 | | | | | | 50PSI | ≤4.3A | |
| LFP0085T-30040 | | | | | | 40PSI | ≤4.0A | |
| LFP0085T-30030 | | | | | | 30PSI | ≤3.6A | |

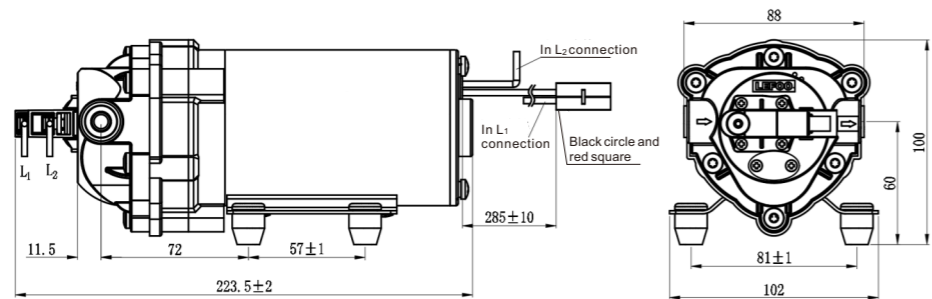

LFP0100T

12VDC 1.0GPM Automatic Shut-Off Demand/Delivery Diaphragm Pump



○ Flow Rate Curve

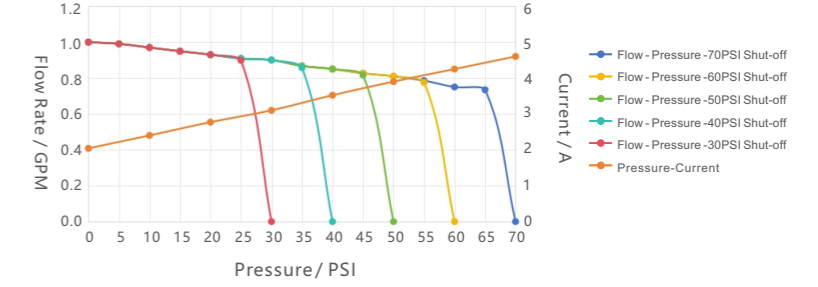

○ Temperature Rise Curve

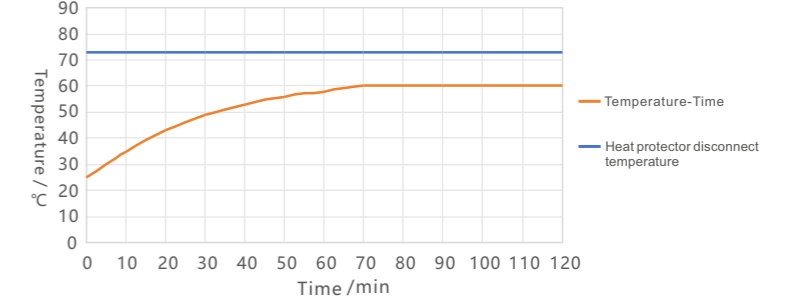

○ Performance data and curves

Data were tested at inlet pressure of 0PSI, ambient temperature and water temperature of 25°C. The above test data are based on a standard pipe of 3/8".

○ Temperature rise curve

The temperature rise curve is measured by the ambient temperature of 25°C, the inlet pressure of 0PSI, and the working pressure of 70PSI. In order to ensure the safety of the motor, the housing temperature exceeds approximately 73 °C, and the thermal protector is disconnected to cool the motor. The motor will be continuous working when the actual temperature rise of the motor is lower than the thermal protection disconnection temperature. All performance data and temperature curves are approximate, and actual conditions will vary with ambient conditions such as temperature.

○ Performance parameter

| Discharge Pressure /PSI | Flow Rate /GPM | Flow Rate /LPM | Current /A |
|-------------------------|----------------|----------------|------------|
| 0 | 1.0 | 3.79 | 2.04 |
| 10 | 0.97 | 3.67 | 2.4 |
| 20 | 0.93 | 3.51 | 2.77 |
| 30 | 0.90 | 3.42 | 3.10 |
| 40 | 0.85 | 3.23 | 3.52 |
| 50 | 0.81 | 3.05 | 3.90 |
| 60 | 0.75 | 2.84 | 4.25 |
| 70 | 0.72 | 2.73 | 4.60 |

○ Shut-off pressure for selection

| Selection | Rated voltage | Inlet Water Pressure | Working Flow Rate | Working Current | Suction | Shut-off Pressure | Maximum current | Connection |
|----------------|---------------|----------------------|-------------------|-----------------|---------|-------------------|-----------------|--|
| LFP0100T-30070 | 12V DC | 0PSI | 1.0GPM | ≤2.8A | ≥2M | 70PSI | ≤5.2A | 3/8" side female quick connector NPT3/8 Screw thread |
| LFP0100T-30060 | | | | | | 60PSI | ≤4.8A | |
| LFP0100T-30050 | | | | | | 50PSI | ≤4.5A | |
| LFP0100T-30040 | | | | | | 40PSI | ≤4.1A | |
| LFP0100T-30030 | | | | | | 30PSI | ≤3.7A | |

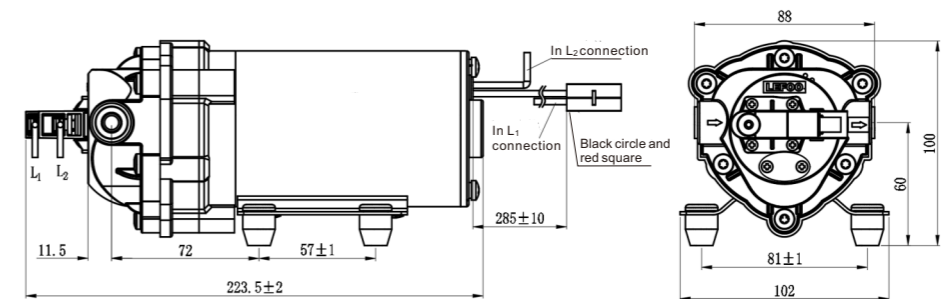

LFP0115T

12VDC 1.5GPM Automatic Shut Off Demand/Delivery Diaphragm Pump



○ Flow Rate Curve

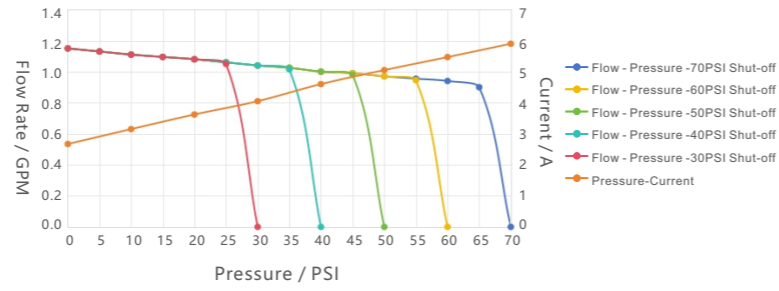

○ Temperature Rise Curve

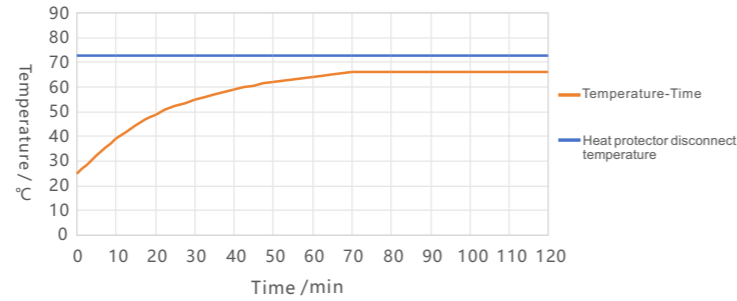

○ Performance data and curves

Data were tested at inlet pressure of 0PSI, ambient temperature and water temperature of 25°C. The above test data are based on a standard pipe of 3/8".

○ Temperature rise curve

The temperature rise curve is measured by the ambient temperature of 25°C, the inlet pressure of 0PSI, and the working pressure of 70PSI. In order to ensure the safety of the motor, the housing temperature exceeds approximately 73 °C, and the thermal protector is disconnected to cool the motor. The motor will be continuous working when the actual temperature rise of the motor is lower than the thermal protection disconnection temperature. All performance data and temperature curves are approximate, and actual conditions will vary with ambient conditions such as temperature.

○ Performance parameter

| Discharge Pressure /PSI | Flow Rate /GPM | Flow Rate /LPM | Current /A |
|-------------------------|----------------|----------------|------------|
| 0 | 1.15 | 4.35 | 2.67 |
| 10 | 1.11 | 4.21 | 3.15 |
| 20 | 1.08 | 4.08 | 3.62 |
| 30 | 1.04 | 3.93 | 4.05 |
| 40 | 1.00 | 3.8 | 4.60 |
| 50 | 0.97 | 3.68 | 5.05 |
| 60 | 0.94 | 3.56 | 5.47 |
| 70 | 0.90 | 3.42 | 5.90 |

○ Shut-off pressure for selection

| Selection | Rated voltage | Inlet Water Pressure | Working Flow Rate | Working Current | Suction | Shut-off Pressure | Maximum current | Connection |
|----------------|---------------|----------------------|-------------------|-----------------|---------|-------------------|-----------------|--|
| LFP0115T-30070 | 12V DC | 0PSI | 1.15GPM | ≤3.2A | ≥2M | 70PSI | ≤6.5A | 3/8" side female quick connector NPT3/8 Screw thread |
| LFP0115T-30060 | | | | | | 60PSI | ≤6.0A | |
| LFP0115T-30050 | | | | | | 50PSI | ≤5.6A | |
| LFP0115T-30040 | | | | | | 40PSI | ≤5.2A | |
| LFP0115T-30030 | | | | | | 30PSI | ≤4.6A | |

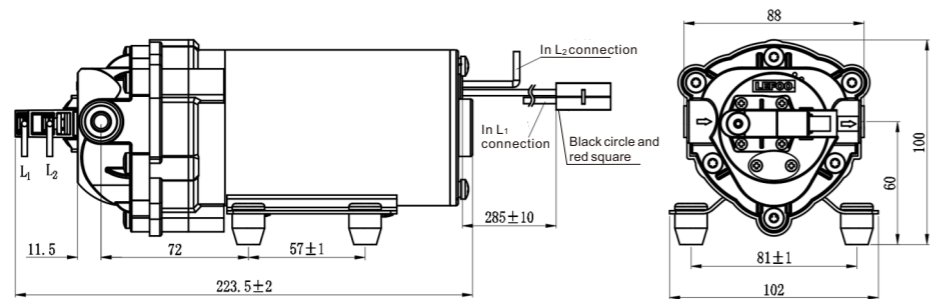

LFP0125T

12VDC 1.25GPM Automatic Shut-Off Demand/Delivery Diaphragm Pump



○ Flow Rate Curve

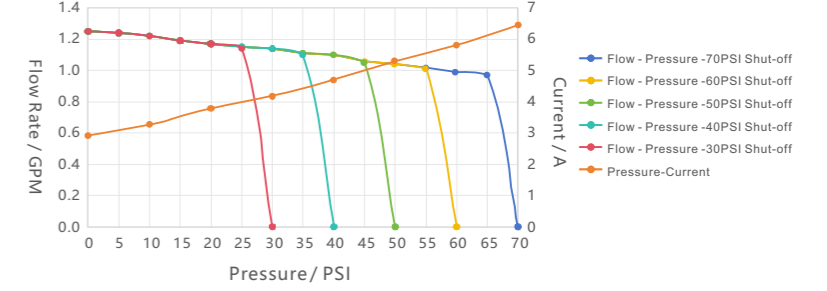

○ Temperature Rise Curve

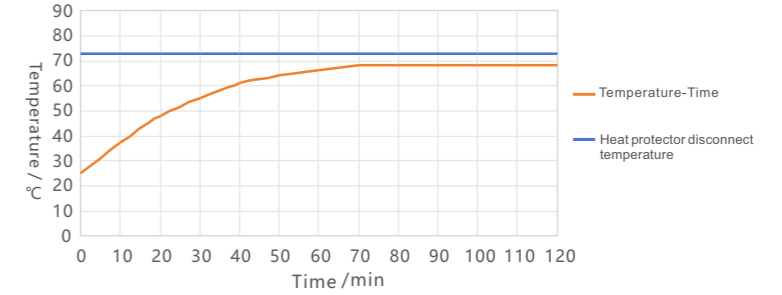

○ Performance data and curves

Data were tested at inlet pressure of 0PSI, ambient temperature and water temperature of 25°C. The above test data are based on a standard pipe of 3/8".

○ Temperature rise curve

The temperature rise curve is measured by the ambient temperature of 25°C, the inlet pressure of 0PSI, and the working pressure of 70PSI. In order to ensure the safety of the motor, the housing temperature exceeds approximately 73 °C, and the thermal protector is disconnected to cool the motor. The motor will be continuous working when the actual temperature rise of the motor is lower than the thermal protection disconnection temperature. All performance data and temperature curves are approximate, and actual conditions will vary with ambient conditions such as temperature.

○ Performance parameter

| Discharge Pressure /PSI | Flow Rate /GPM | Flow Rate /LPM | Current /A |
|-------------------------|----------------|----------------|------------|
| 0 | 1.25 | 4.73 | 2.92 |
| 10 | 1.22 | 4.61 | 3.27 |
| 20 | 1.17 | 4.44 | 3.79 |
| 30 | 1.14 | 4.31 | 4.18 |
| 40 | 1.1 | 4.15 | 4.7 |
| 50 | 1.04 | 3.93 | 5.3 |
| 60 | 0.99 | 3.74 | 5.8 |
| 70 | 0.95 | 3.61 | 6.45 |

○ Shut-off pressure for selection

| Selection | Rated voltage | Inlet Water Pressure | Working Flow Rate | Working Current | Suction | Shut-off Pressure | Maximum current | Connection |
|----------------|---------------|----------------------|-------------------|-----------------|---------|-------------------|-----------------|--|
| LFP0125T-30070 | 12V DC | 0PSI | 1.25GPM | ≤3.8A | ≥2M | 70PSI | ≤7.0A | 3/8" side female quick connector NPT3/8 Screw thread |
| LFP0125T-30060 | | | | | | 60PSI | ≤6.4A | |
| LFP0125T-30050 | | | | | | 50PSI | ≤5.9A | |
| LFP0125T-30040 | | | | | | 40PSI | ≤5.3A | |
| LFP0125T-30030 | | | | | | 30PSI | ≤4.8A | |

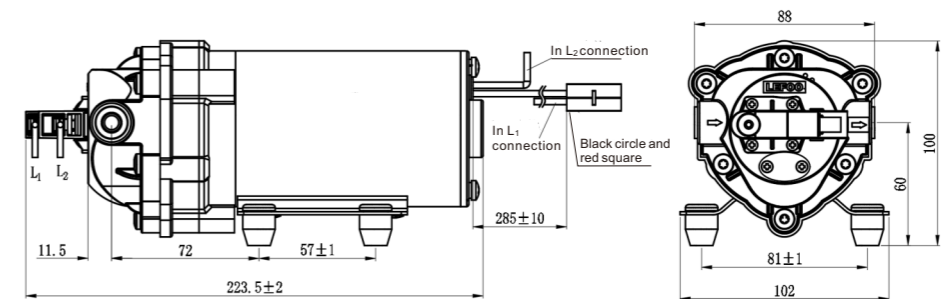

LFP0140T

12VDC 1.4GPM Automatic Shut Off Demand/Delivery Diaphragm Pump



Flow Rate Curve

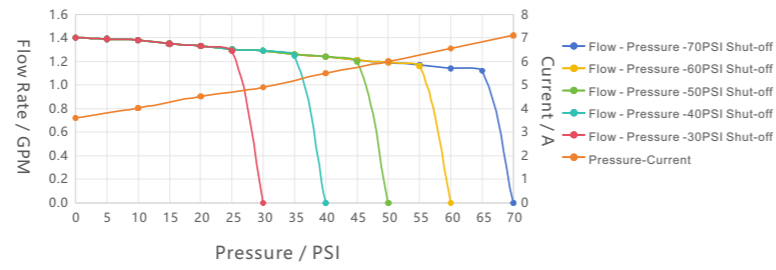

Temperature Rise Curve

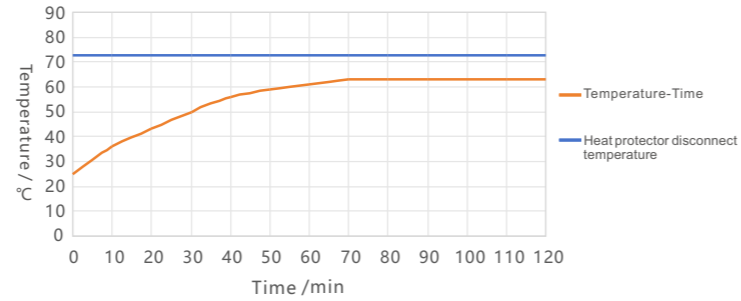

Performance data and curves

Data were tested at inlet pressure of 0PSI, ambient temperature and water temperature of 25°C. The above test data are based on a standard pipe of 3/8".

Temperature rise curve

The temperature rise curve is measured by the ambient temperature of 25°C, the inlet pressure of 0PSI, and the working pressure of 70PSI. In order to ensure the safety of the motor, the housing temperature exceeds approximately 73 °C, and the thermal protector is disconnected to cool the motor. The motor will be continuous working when the actual temperature rise of the motor is lower than the thermal protection disconnection temperature. All performance data and temperature curves are approximate, and actual conditions will vary with ambient conditions such as temperature.

Performance parameter

| Discharge Pressure /PSI | Flow Rate /GPM | Flow Rate /LPM | Current /A |
|-------------------------|----------------|----------------|------------|
| 0 | 1.40 | 5.30 | 3.6 |
| 10 | 1.38 | 5.21 | 4.02 |
| 20 | 1.33 | 5.04 | 4.52 |
| 30 | 1.29 | 4.88 | 4.9 |
| 40 | 1.24 | 4.71 | 5.5 |
| 50 | 1.19 | 4.52 | 6.0 |
| 60 | 1.14 | 4.30 | 6.55 |
| 70 | 1.10 | 4.18 | 7.10 |

Shut-off pressure for selection

| Selection | Rated voltage | Inlet Water Pressure | Working Flow Rate | Working Current | Suction | Shut-off Pressure | Maximum current | Connection |
|----------------|---------------|----------------------|-------------------|-----------------|---------|-------------------|-----------------|--|
| LFP0140T-30070 | 12V DC | 0PSI | 1.40GPM | ≤4.2A | ≥2M | 70PSI | ≤7.7A | 3/8" side female quick connector NPT3/8 Screw thread |
| LFP0140T-30060 | | | | | | 60PSI | ≤7.1A | |
| LFP0140T-30050 | | | | | | 50PSI | ≤6.6A | |
| LFP0140T-30040 | | | | | | 40PSI | ≤6.1A | |
| LFP0140T-30030 | | | | | | 30PSI | ≤5.5A | |

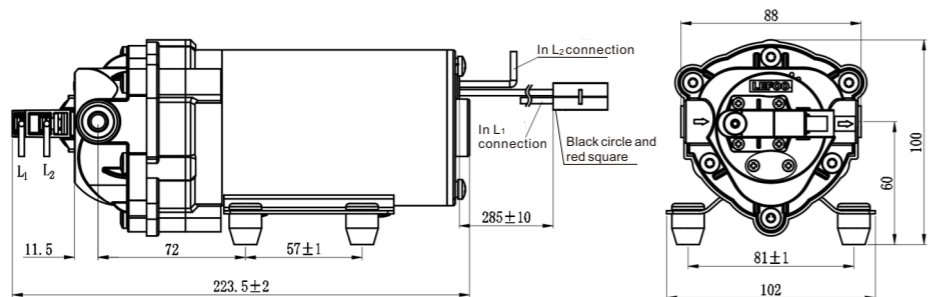

LFP0150T

12VDC 1.5GPM Automatic Shut-Off Demand/Delivery Diaphragm Pump



Flow Rate Curve

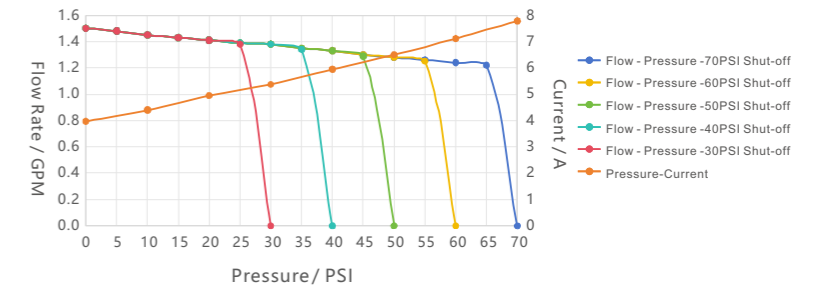

Temperature Rise Curve

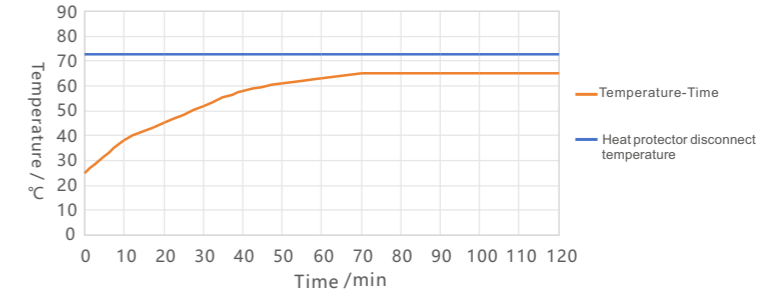

Performance data and curves

Data were tested at inlet pressure of 0PSI, ambient temperature and water temperature of 25°C. The above test data are based on a standard pipe of 3/8".

Temperature rise curve

The temperature rise curve is measured by the ambient temperature of 25°C, the inlet pressure of 0PSI, and the working pressure of 70PSI. In order to ensure the safety of the motor, the housing temperature exceeds approximately 73 °C, and the thermal protector is disconnected to cool the motor. The motor will be continuous working when the actual temperature rise of the motor is lower than the thermal protection disconnection temperature. All performance data and temperature curves are approximate, and actual conditions will vary with ambient conditions such as temperature.

Performance parameter

| Discharge Pressure /PSI | Flow Rate /GPM | Flow Rate /LPM | Current /A |
|-------------------------|----------------|----------------|------------|
| 0 | 1.50 | 5.68 | 3.97 |
| 10 | 1.45 | 5.50 | 4.4 |
| 20 | 1.41 | 5.33 | 4.95 |
| 30 | 1.38 | 5.22 | 5.37 |
| 40 | 1.33 | 5.03 | 5.95 |
| 50 | 1.28 | 4.85 | 6.5 |
| 60 | 1.24 | 4.70 | 7.11 |
| 70 | 1.20 | 4.54 | 7.78 |

Shut-off pressure for selection

| Selection | Rated voltage | Inlet Water Pressure | Working Flow Rate | Working Current | Suction | Shut-off Pressure | Maximum current | Connection |
|----------------|---------------|----------------------|-------------------|-----------------|---------|-------------------|-----------------|--|
| LFP0150T-30070 | 12V DC | 0PSI | 1.50GPM | ≤4.6A | ≥2M | 70PSI | ≤8.4A | 3/8" side female quick connector NPT3/8 Screw thread |
| LFP0150T-30060 | | | | | | 60PSI | ≤7.7A | |
| LFP0150T-30050 | | | | | | 50PSI | ≤7.1A | |
| LFP0150T-30040 | | | | | | 40PSI | ≤6.6A | |
| LFP0150T-30030 | | | | | | 30PSI | ≤6.0A | |

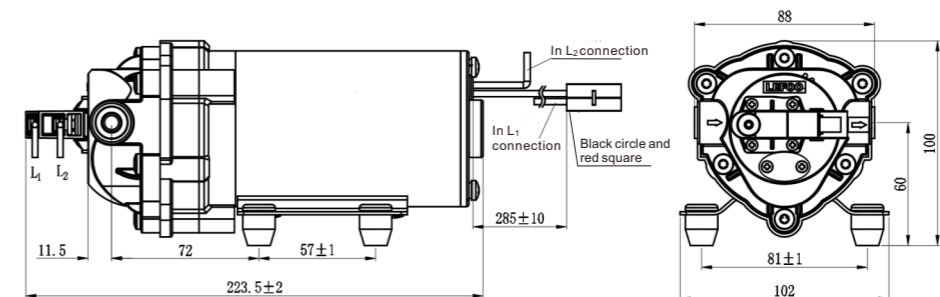

LFP1060T

24VDC 0.6GPM Automatic Shut Off Demand/Delivery Diaphragm Pump



○ Flow Rate Curve

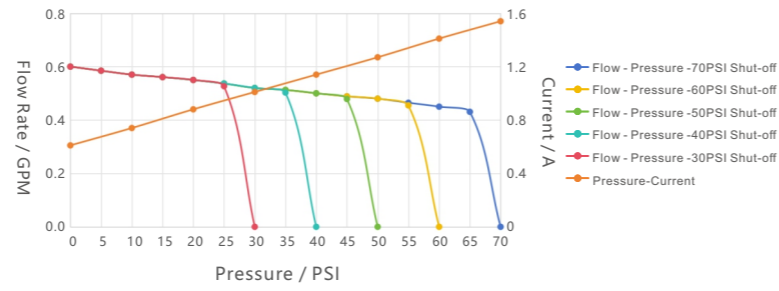

○ Temperature Rise Curve

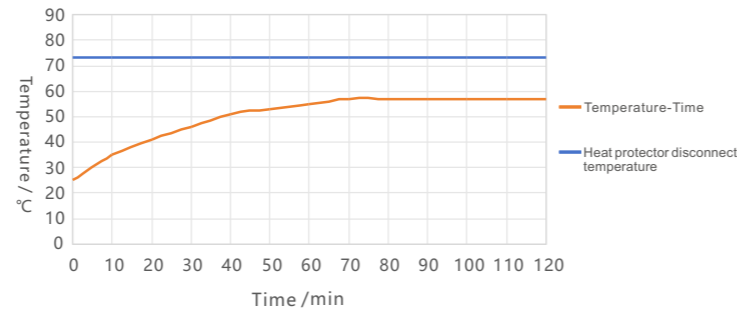

○ Performance data and curves

Data were tested at inlet pressure of 0PSI, ambient temperature and water temperature of 25°C. The above test data are based on a standard pipe of 3/8".

○ Temperature rise curve

The temperature rise curve is measured by the ambient temperature of 25°C, the inlet pressure of 0PSI, and the working pressure of 70PSI. In order to ensure the safety of the motor, the housing temperature exceeds approximately 73 °C, and the thermal protector is disconnected to cool the motor. The motor will be continuous working when the actual temperature rise of the motor is lower than the thermal protection disconnection temperature. All performance data and temperature curves are approximate, and actual conditions will vary with ambient conditions such as temperature.

○ Performance parameter

| Discharge Pressure /PSI | Flow Rate /GPM | Flow Rate /LPM | Current /A |
|-------------------------|----------------|----------------|------------|
| 0 | 0.60 | 2.27 | 0.61 |
| 10 | 0.57 | 2.16 | 0.74 |
| 20 | 0.55 | 2.08 | 0.88 |
| 30 | 0.52 | 1.97 | 1.01 |
| 40 | 0.50 | 1.89 | 1.14 |
| 50 | 0.48 | 1.82 | 1.27 |
| 60 | 0.45 | 1.70 | 1.41 |
| 70 | 0.43 | 1.63 | 1.54 |

○ Shut-off pressure for selection

| Selection | Rated voltage | Inlet Water Pressure | Working Flow Rate | Working Current | Suction | Shut-off Pressure | Maximum current | Connection |
|----------------|---------------|----------------------|-------------------|-----------------|---------|-------------------|-----------------|--|
| LFP1060T-30070 | 24V DC | 0PSI | 0.6GPM | ≤1.0A | ≥2M | 70PSI | ≤1.9A | 3/8" side female quick connector NPT3/8 Screw thread |
| LFP1060T-30060 | | | | | | 60PSI | ≤1.8A | |
| LFP1060T-30050 | | | | | | 50PSI | ≤1.7A | |
| LFP1060T-30040 | | | | | | 40PSI | ≤1.5A | |
| LFP1060T-30030 | | | | | | 30PSI | ≤1.4A | |

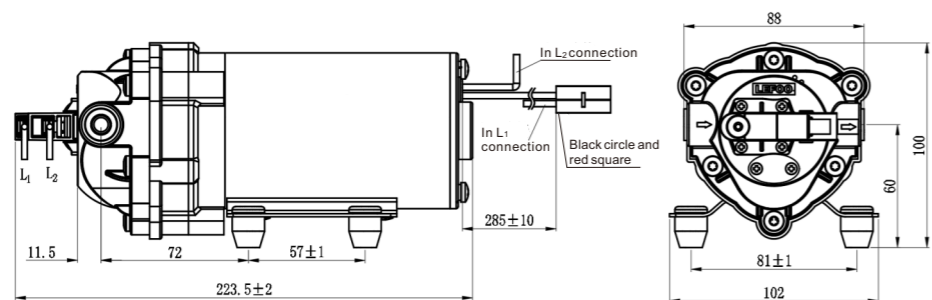

LFP1075T

24VDC 0.75GPM Automatic Shut-Off Demand/Delivery Diaphragm Pump



○ Flow Rate Curve

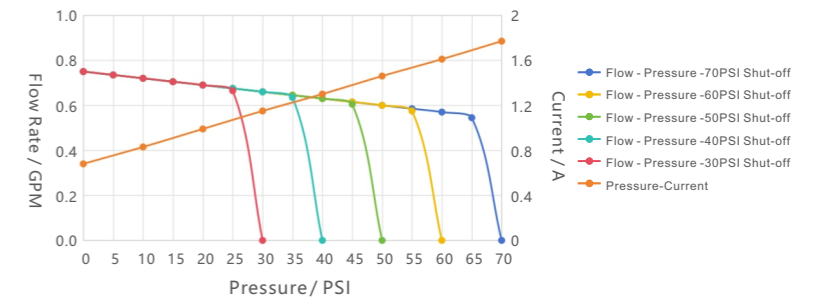

○ Temperature Rise Curve

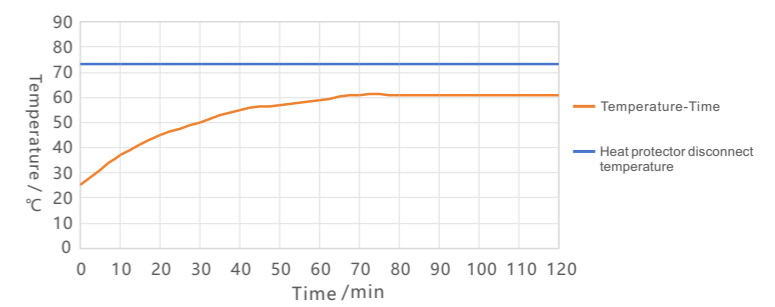

○ Performance data and curves

Data were tested at inlet pressure of 0PSI, ambient temperature and water temperature of 25°C. The above test data are based on a standard pipe of 3/8".

○ Temperature rise curve

The temperature rise curve is measured by the ambient temperature of 25°C, the inlet pressure of 0PSI, and the working pressure of 70PSI. In order to ensure the safety of the motor, the housing temperature exceeds approximately 73 °C, and the thermal protector is disconnected to cool the motor. The motor will be continuous working when the actual temperature rise of the motor is lower than the thermal protection disconnection temperature. All performance data and temperature curves are approximate, and actual conditions will vary with ambient conditions such as temperature.

○ Performance parameter

| Discharge Pressure /PSI | Flow Rate /GPM | Flow Rate /LPM | Current /A |
|-------------------------|----------------|----------------|------------|
| 0 | 0.75 | 2.84 | 0.68 |
| 10 | 0.72 | 2.73 | 0.83 |
| 20 | 0.69 | 2.61 | 0.99 |
| 30 | 0.66 | 2.50 | 1.15 |
| 40 | 0.63 | 2.39 | 1.3 |
| 50 | 0.60 | 2.27 | 1.46 |
| 60 | 0.57 | 2.16 | 1.61 |
| 70 | 0.54 | 2.05 | 1.77 |

○ Shut-off pressure for selection

| Selection | Rated voltage | Inlet Water Pressure | Working Flow Rate | Working Current | Suction | Shut-off Pressure | Maximum current | Connection |
|----------------|---------------|----------------------|-------------------|-----------------|---------|-------------------|-----------------|--|
| LFP1075T-30070 | 24V DC | 0PSI | 0.75GPM | ≤1.1A | ≥2M | 70PSI | ≤2.1A | 3/8" side female quick connector NPT3/8 Screw thread |
| LFP1075T-30060 | | | | | | 60PSI | ≤2.0A | |
| LFP1075T-30050 | | | | | | 50PSI | ≤1.8A | |
| LFP1075T-30040 | | | | | | 40PSI | ≤1.7A | |
| LFP1075T-30030 | | | | | | 30PSI | ≤1.5A | |

